

AgieCharmilles

# CUT E

350/600



# Becoming better every day – since 1802

## GF Machining Solutions

When all you need is everything, it's good to know that there is one company that you can count on to deliver complete solutions and services. From unmatched Electrical Discharge Machining (EDM), Laser texturing, Laser micromachining, Additive Manufacturing and first-class Milling and Spindles to Tooling and Automation, all of our solutions are backed by unrivaled customer service and expert GF Machining Solutions training. Our AgieCharmilles, Microlution, Mikron Mill, Liechti, Step-Tec and System 3R technologies help you raise your game—and our digital business solutions for intelligent manufacturing, offering embedded expertise and optimized production processes across all industries, increase your competitive edge.



+ We are AgieCharmilles.  
We are GF Machining Solutions.

# Contents

4	Key points
6	Intelligence inside
8	Machine concept
10	GF Machining Solutions quality
12	Numerical control and interface
14	Digital IPG generator
18	Machine performance
19	Machine options
20	Customer Services
21	Certified wires
22	Technical specifications
26	GF Machining Solutions

**Experience flexible, intelligent job management,  
speed-dedicated processes**

The CUT E 350/CUT E 600 range puts efficiency at the touch of your finger with a smart, easy-to-use human-machine interface (HMI) and onboard technologies that streamline your job setup, improve your cutting speed, improve your surface finish, protect your valuable workpieces, and ensure your process robustness.

## Key points

# Touch your success



### **GF Machining Solutions innovation keeps you ahead**

GF Machining Solutions tradition for constant innovation and strict quality standard push back the boundaries.

### **Benefit from our expertise**

You benefit from GF Machining Solutions' legacy of more than 60 years of EDM expertise. We attach extreme importance to our ability to provide you highly competent application support, Customer Services and business support for your specific field.



### **Power your performance**

Your business performance is powered by machine performance. Our Intelligent Power Generator (IPG) boasts a wide range of expert technologies helping you to achieve the surface quality and precision your discerning customers demand.

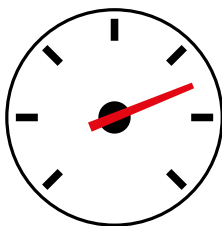

### **Accelerate your productivity**

Time saved is money earned. Onboard speed technology package puts you on the fast track to provide excellent performance at an affordable price.



### **Experience ergonomics**

You're just one click away from machining perfect punches, dies, molds and parts, thanks to our intelligent, intuitive AC CUT HMI. Included are powerful tools for fast, safe machining preparation to make your machine programmer's life easier. Industry 4.0 at the tip of your finger.



Intelligence inside

# Expert solutions for your success

You benefit from GF Machining Solutions' legacy of more than 60 years of EDM expertise. That expertise informs our solutions and triggers your success.

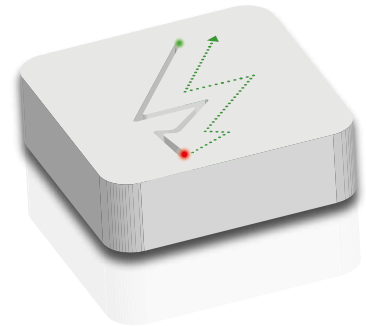
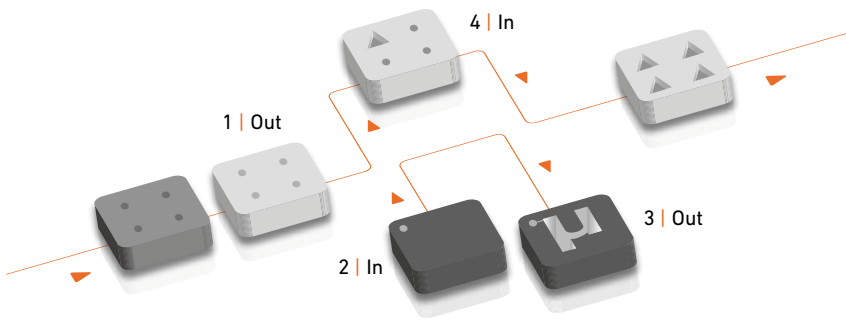

## PART EXPRESS

Operators sometimes face unexpected situations. It is very common to be confronted with a change in priorities in the flow of production. With AC CUT HMI, the insertion of an urgent machining job can be done in a simple, rapid and reliable manner and you can resume the previous work exactly where it was interrupted.

## AUTO RESTART

If the power goes out, the point and the job name are memorized, allowing a direct re-start of the job after power is restored.



## Integrated Collision Protection (ICP) saves you money

Your operator can work with greater confidence during job preparation and execution, because the ICP on the X, Y and Z axes protects sensitive workpieces from damage.

## TAPER-EXPERT

### Mastery of large tapers

TAPER-EXPERT allows very precise machining of taper with angle varying from 0 to 30°. Thanks to a dedicated measuring cycle, the position of the guides will be defined accurately according to the angle. During machining, the position of the wire will be corrected automatically according to this measuring cycle result. Despite angles up to 30°, the surface quality is close to cylindrical machining.

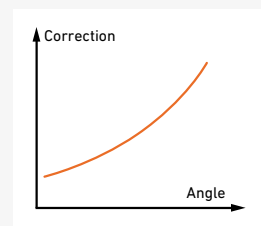
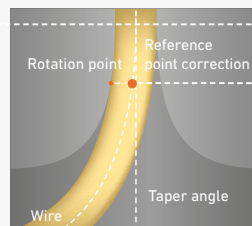
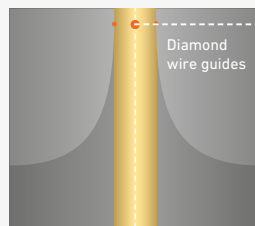

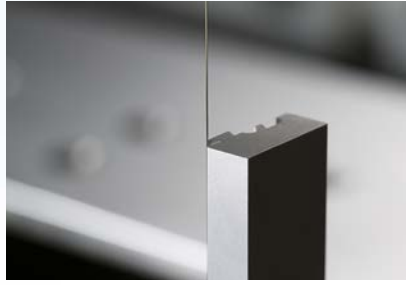
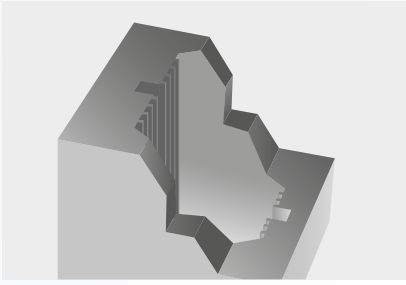

#### **POWER-EXPERT**

##### **Wire breakage prevention on parts with variable heights**

This smart module continually analyzes the machining conditions and adapts the power according to the geometry modifications. Critical situations such as when the part is approaching or crossing a blind hole, are fully automatically controlled by POWER-EXPERT.

#### **WIRE-EXPERT**

##### **Precision over height**

Control of the conicity of the piece compensates for the wire wearing across the height.

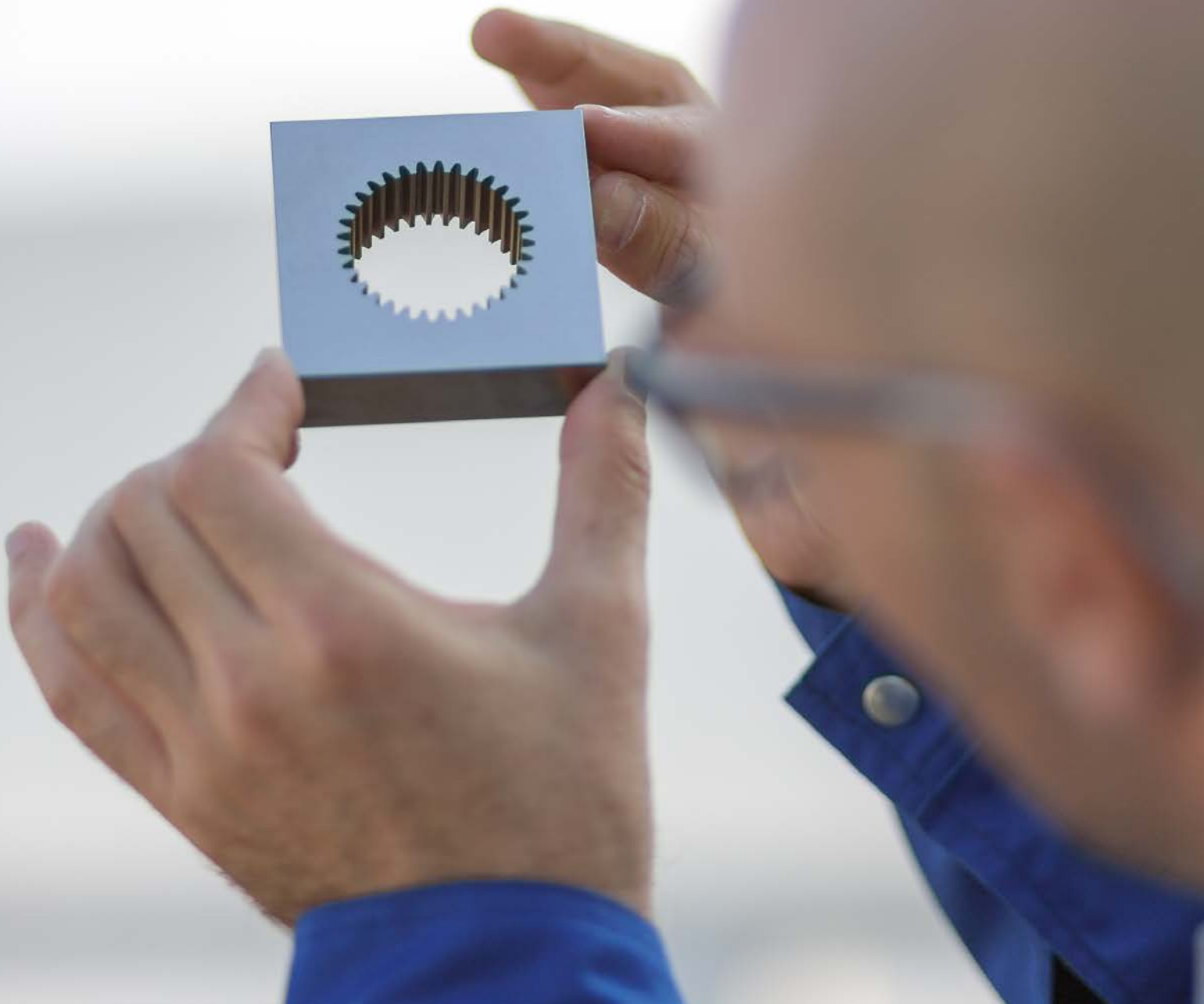



#### Filters

For easy operation. We positioned the two filters side by side to make maintenance fast and easy.

**Uses 30 percent less floor space compare to previous model**

#### Compact layout

For space savings. The compact layout of about four square meters allows efficient integration of the CUT E series into your workshop.

#### Drop door

For best use of workshop space. The standard drop door system allows easy and convenient access to the working zone.



## Machine concept

# New design, new features based on years of legacy

Solutions to advance your performance and productivity, secure your processes, and accelerate your time to market are engineered into the CUT E 350/CUT E 600 wire-cutting EDM machines

### Thermocut for easy operation

Your key to successful, efficient threading is preparing the wire properly before threading, thanks to the Thermocut module.

### Wire circuit

Reliable table wire circuit design ensures a perfect unrolling process that does not disrupt the EDM process during machining.

### Automatic threading

The automatic threading and rethreading is rapid and useful for all kinds of coated and uncoated and hard and soft brass wires.



### Automatic indexing chuck

Autoindexer is an integrated rotary indexing unit with continuous 90° capability intended for submerged use in wire EDM machines.



### Remote control

Designed for one-handed use, the remote control is a standard feature offering ease of use and help in fine tuning workpiece preparation.

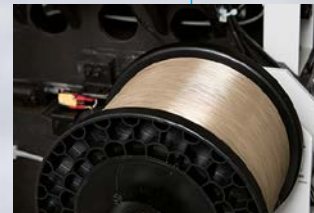

### Large spool

A 25 kg spool option is available for both the CUT E 350 and the CUT E 600 to extend running hours and allow continuous production in combination with  
– 20-liter deionizing bottle  
– Two filter cartridges

## Save energy: an economic and ecological necessity

In order to control production costs, saving energy has become a priority in many workshops. The Econowatt modules manage the electrical power of the machine so as to never waste energy when the machine is running unattended. When machining is finished or interrupted, the power supply is reduced to the minimum, lower than 1 kW, or completely disconnected depending on the parameters of the machine. Automatic restart is programmed according to a daily schedule corresponding to the working hours of the workshop. The machine is switched on in sufficient time to be thermostabilized when the workshop opens.

GF Machining Solutions quality

# Engineered for precision and repeatability

The CUT E series is designed to make it easy for you to accurately machine even large, heavy workpieces. You can count on highly repeatable results.



## **T shape**

For accuracy. The T-shaped based frame permits loading of large and heavy work pieces. The compactness and independence of the XY/UV axes guarantee good positioning accuracy and highly repeatable results.

## **Large/heavy workpieces**

Thanks to the standard drop door, large and heavy workpieces up to 1,000 kg can be easily loaded and unloaded.

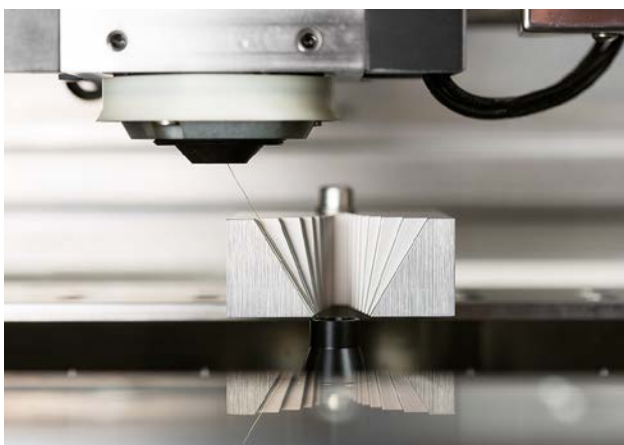

### **Taper**

Precision cuts up to 30° over 56 mm are enabled by a compact and flexible mechanical concept.



### **Glass scales**

For repeatability. The glass scales preserve long-term accuracy, require no recalibration, and eliminate classical screw system errors related to backlash and wear.

## Numerical control and interface

# A new era of functionalities with an ergonomic HMI

With a 19-inch touch screen with pinch-and-pull effect for high detail accuracy, intuitive logic for fast learning, and a new hand box designed for one-hand use, the AC CUT HMI makes fast work of programming multi-cavity and multi-technology jobs.

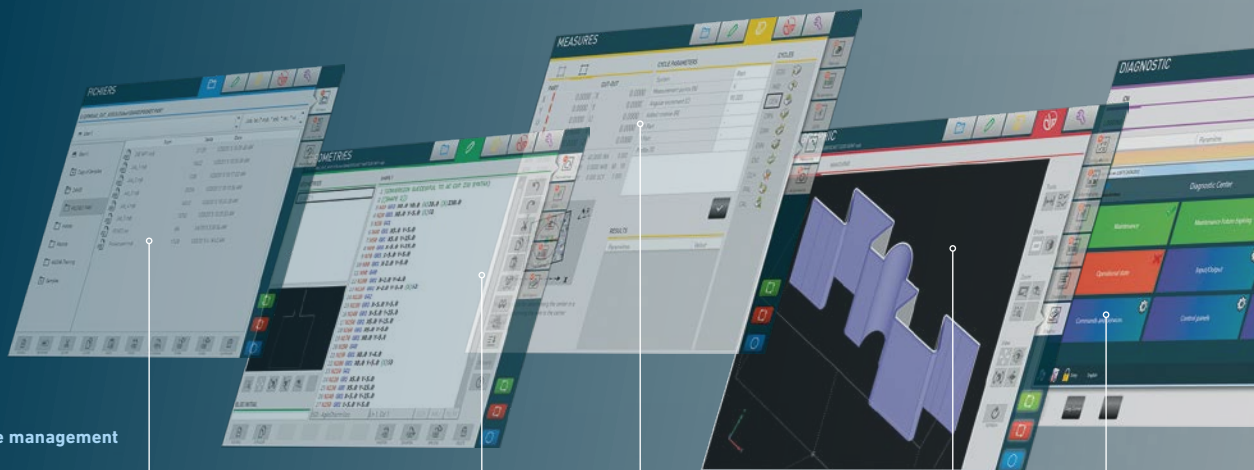

### File management

Manage folders and files, create a new job folder, send an existing job to **preparation** or **execution** modes

You can easily organize the execution of a succession of jobs, get the status of each job executed, and create and store job reports

Get autonomy by access to AC CAM EASY programming system

### Programming

Allows import or creation of geometries to be cut

Defines machining conditions and sequences with our EDM EXPERT function

Organizes the succession of operations

Offers tables to store variables and points

Allows 3D graphic preview of the job execution

### Execution and monitoring

Configure & follow-up the execution of a job

Provides a job execution cockpit

Displays current job's variables and points

Allows optional block management, wire threading and cut configuration

Displays current job's operations that allows monitoring graphically the execution progress

### Manual mode setup

Directly access the main machine functions, perform manual measurements, run manual movements, and perform manual machining

Offers tables to store variables and points and displays machine variables

Select, modify and load generator setting for manual machining

Gives a feedback about machining conditions

Offers numerous measuring cycles to allow part reference pick-up

### Configuration and maintenance

Manages wire, deionization resins and filters consumption

Allows user to set preferences and adjust user's profile

Allows setting and calibrating machine functions, taking axis references

Displays the current configuration of the system

Allows to set and activate e-connection functions

Area which provides relevant information about consumables, job execution and messages

Area that allows programming, execution and monitoring of the fields

Operator's panel and keyboard for manual data input (MDI)

**19-inch touch screen**  
The 19-inch touch screen gives you a clear view of the process management. Job preparation, monitoring of the current job, and various function are available in a single view.



Digital IPG generator

# Power your performance

Your efficient production is at the heart of the modern IPG. Its onboard technologies boost cutting speed, precision and surface quality to satisfy your customers and put you ahead of your competitors.

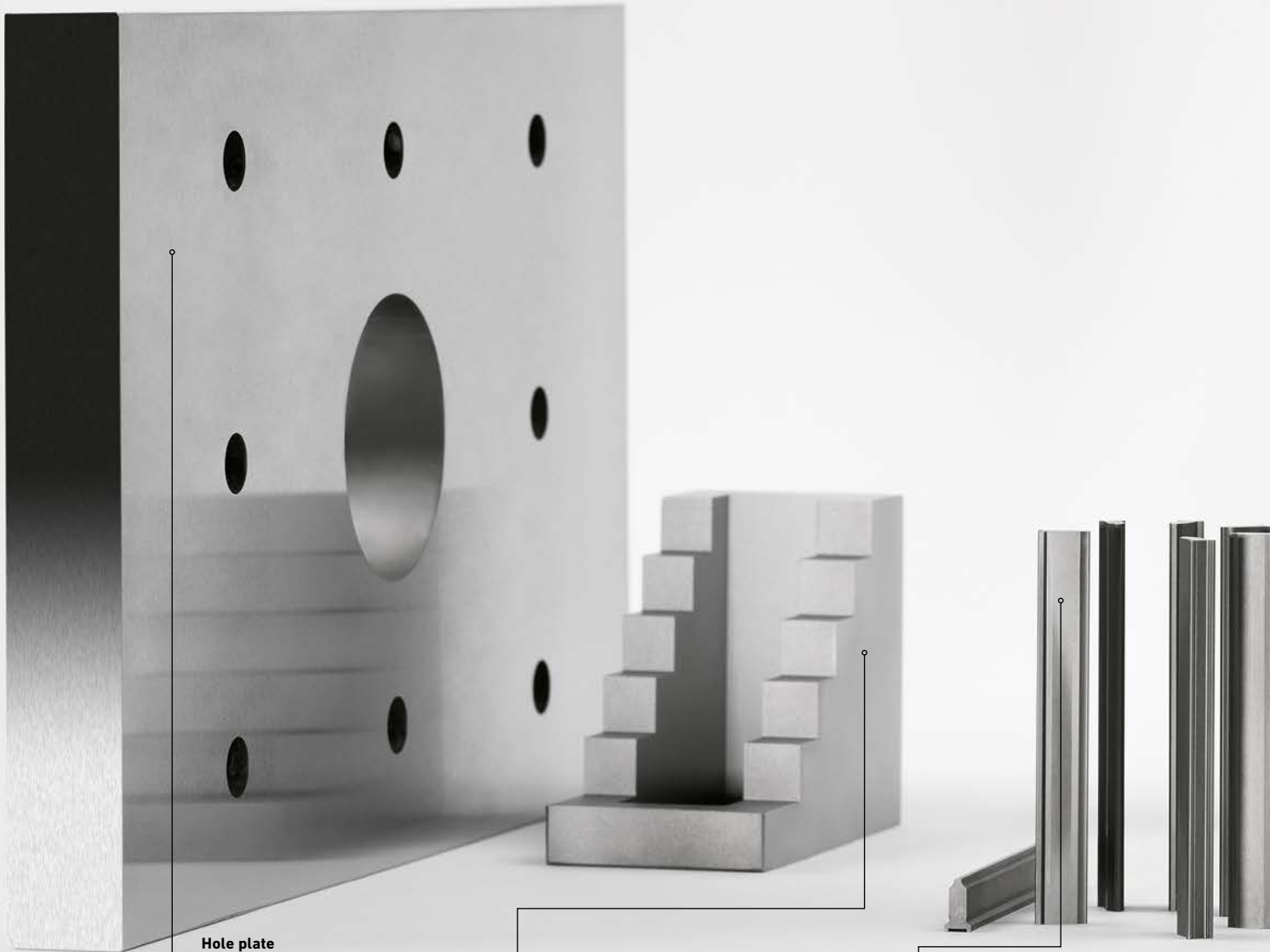

#### Hole plate

- Dimensions: 250 x 150 x 15 mm
- Steel
- AC Cut AH (brass coated) wire
- Five cuts
- Positioning accuracy:  $\pm 3 \mu\text{m}$
- Surface roughness: Ra 0.22  $\mu\text{m}$

#### Variable height

The POWER-EXPERT module decides the optimal power to send in the wire, and is especially efficient for stepped parts.

- Height: 10-60 mm
- Steel
- AC Brass 900 (hard) wire
- Three cuts
- Surface roughness: Ra 0.55  $\mu\text{m}$

#### Stamping punch

The corner strategy module automatically adjusts the parameters during changes of direction to ensure sharp angles and small radii.

- Height: 60 mm
- Steel
- AC Cut AH (brass coated) wire
- Five cuts
- Contour accuracy:  $\pm 5 \mu\text{m}$

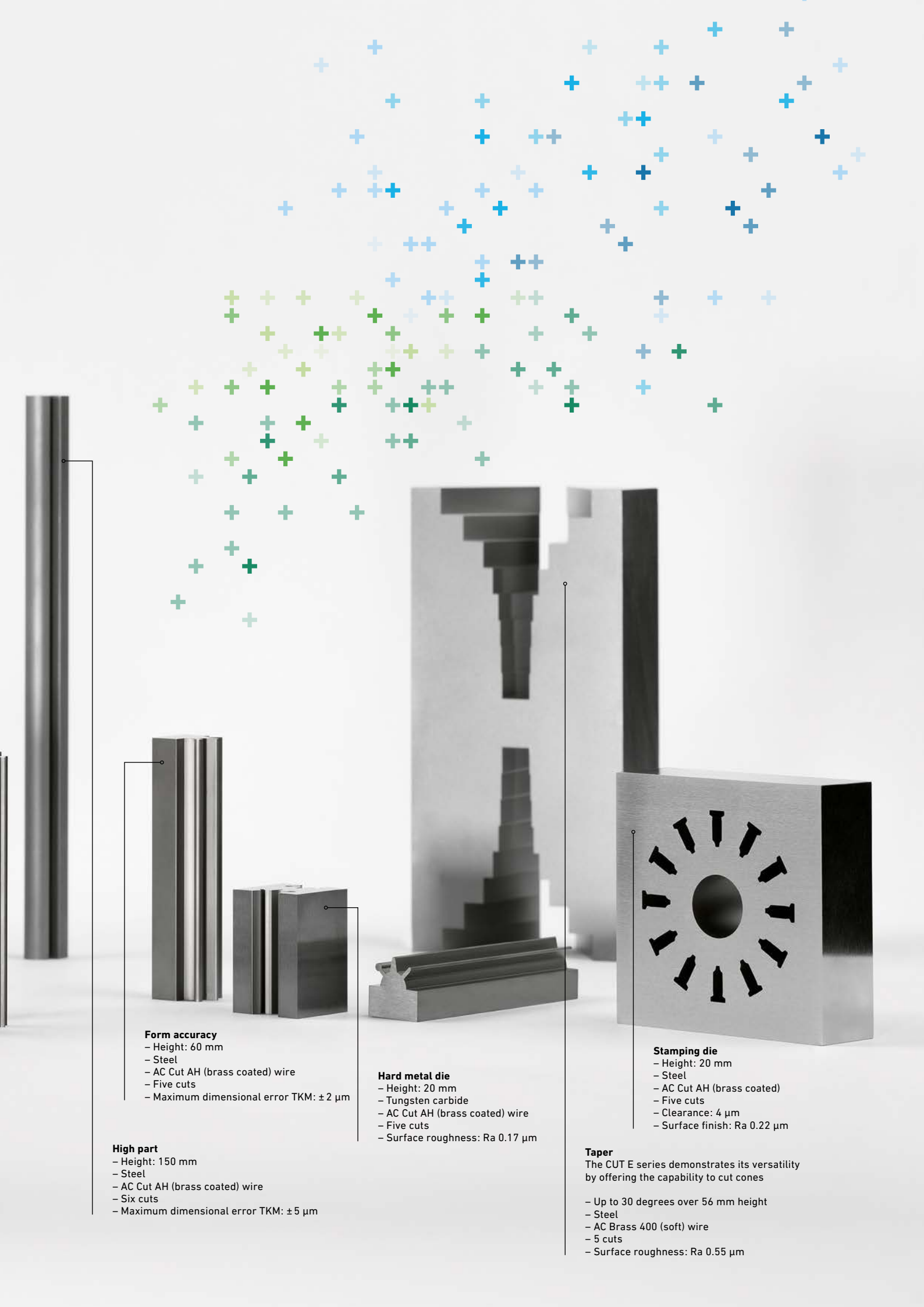

**Form accuracy**

- Height: 60 mm
- Steel
- AC Cut AH (brass coated) wire
- Five cuts
- Maximum dimensional error TKM:  $\pm 2 \mu\text{m}$

**High part**

- Height: 150 mm
- Steel
- AC Cut AH (brass coated) wire
- Six cuts
- Maximum dimensional error TKM:  $\pm 5 \mu\text{m}$

**Hard metal die**

- Height: 20 mm
- Tungsten carbide
- AC Cut AH (brass coated) wire
- Five cuts
- Surface roughness: Ra 0.17  $\mu\text{m}$

**Stamping die**

- Height: 20 mm
- Steel
- AC Cut AH (brass coated)
- Five cuts
- Clearance: 4  $\mu\text{m}$
- Surface finish: Ra 0.22  $\mu\text{m}$

**Taper**

The CUT E series demonstrates its versatility by offering the capability to cut cones

- Up to 30 degrees over 56 mm height
- Steel
- AC Brass 400 (soft) wire
- 5 cuts
- Surface roughness: Ra 0.55  $\mu\text{m}$

Digital IPG generator

# Dedicated to accelerate your productivity

Our latest anti-electrolysis IPG generator combined renewed state of the art CNC control is the new base for the next generation GF Machining Solutions machines. The future is here.



## Electronic integration

The latest generation of GF Machining Solutions' power generators allows a digital control of each spark allowing precision and very fine surface quality down to Ra 0.16  $\mu\text{m}$ .





### Easy EDM management

EDM EXPERT module generates the best process according to precision and material needs. A large panel of preconfigured technological parameters enables an optimal choice of parameters for your application. Combined with the latest state of the art GF Machining Solutions wires enables excellent performances.

### Steel dedicated process range

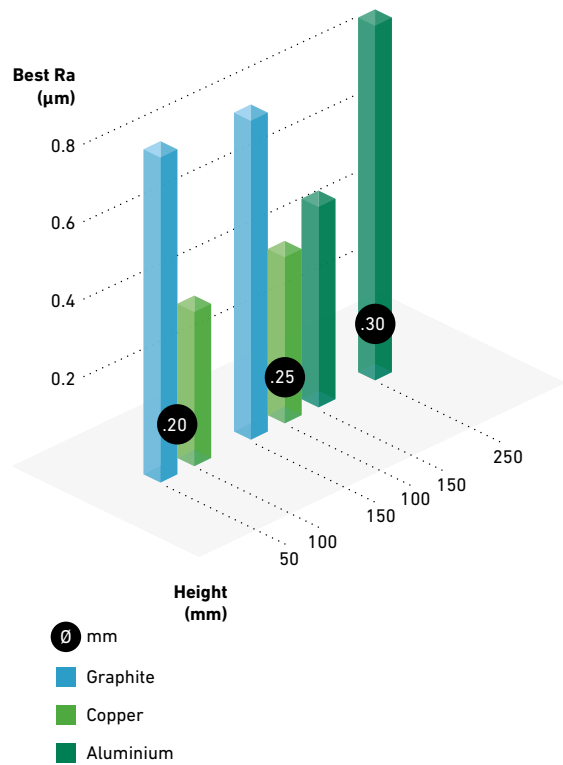
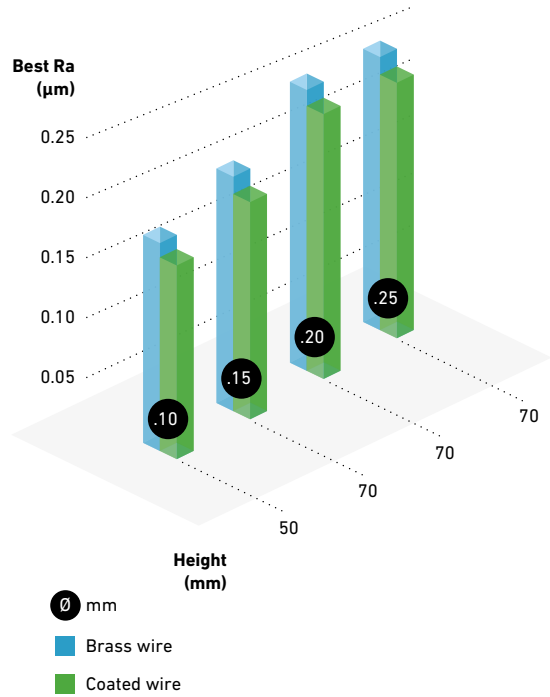
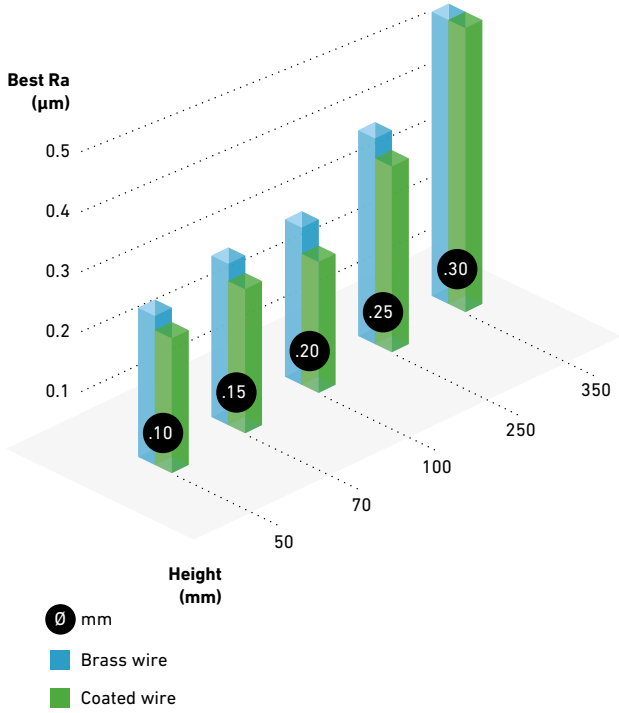

### Speed dedicated process

Focusing on productivity, the integrated processes are saving you time and can reduce cutting time by as much as 18 percent compared to equivalent standard machines.

### AC Cut VS

A wire EDM machine has a very wide range of applications and the choice of wire is crucial in order to obtain the best productivity and optimum results in terms of speed, precision and surface finish. The GF Machining Solutions AC Cut VS certified wire accelerates cutting speed that allows to increase machining speed up to 15%.

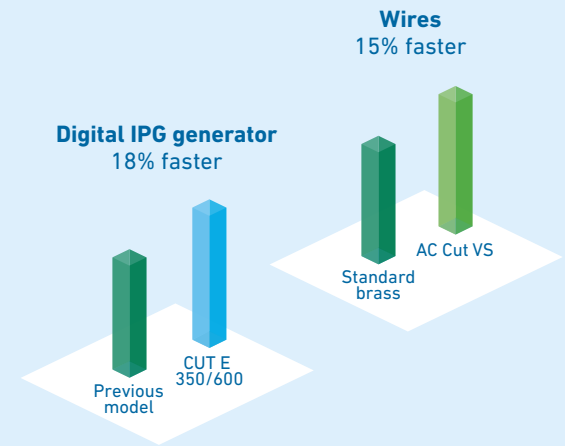

## Machine performance

# Outstanding precision and repeatability

This part was machined under the conditions our customers face daily in the stamping industry. It demonstrates the excellent machining capabilities essential for precision parts: remarkable form accuracy, excellent contour precision, exemplary surface quality and outstanding production repeatability—four reasons to buy a CUT E series machine.

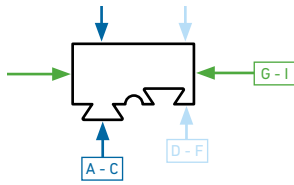

### TKM

Maximal error (e) calculated by subtracting highest from lowest deviations compared to nominal on dimensional measures A to I.

$$TKM = \frac{\text{Max}(e_{A-I}) - \text{Min}(e_{A-I})}{2} = \pm 2 \mu\text{m}$$

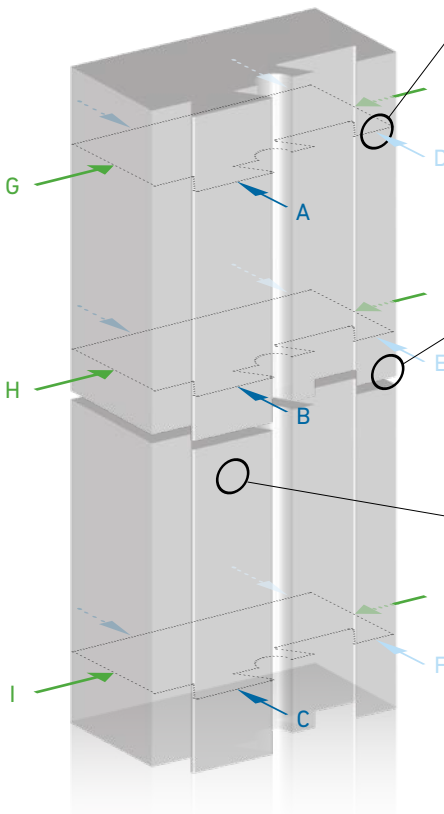

### Contour accuracy

± 5 μm maximal deviation measured on contour at three heights. Shows imperfections on angles.

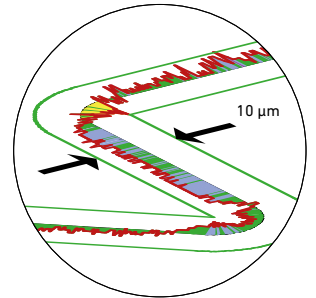

### Geometrical accuracy

Parallelism

//	2.5 μm	Z
----	--------	---

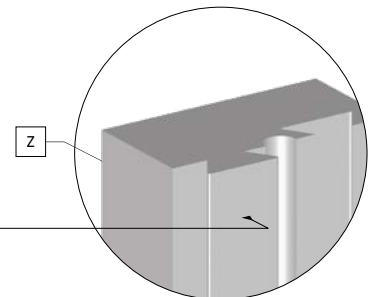

### Corner strategy

The corner strategies adjust automatically the machining parameters during changes of direction. Even on the smallest details, high geometrical accuracy is obtained.

To ensure accuracy of:

- Sharp angles
- Small radii

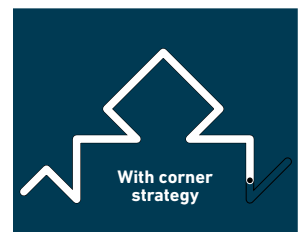
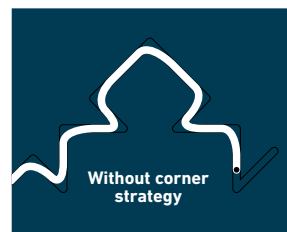

## Machine options

# Customize your solution

Make your CUT E 350/CUT E 600 solution distinctly yours by customizing it to your specific workshop needs. It's as easy as choosing from our wide range of options.

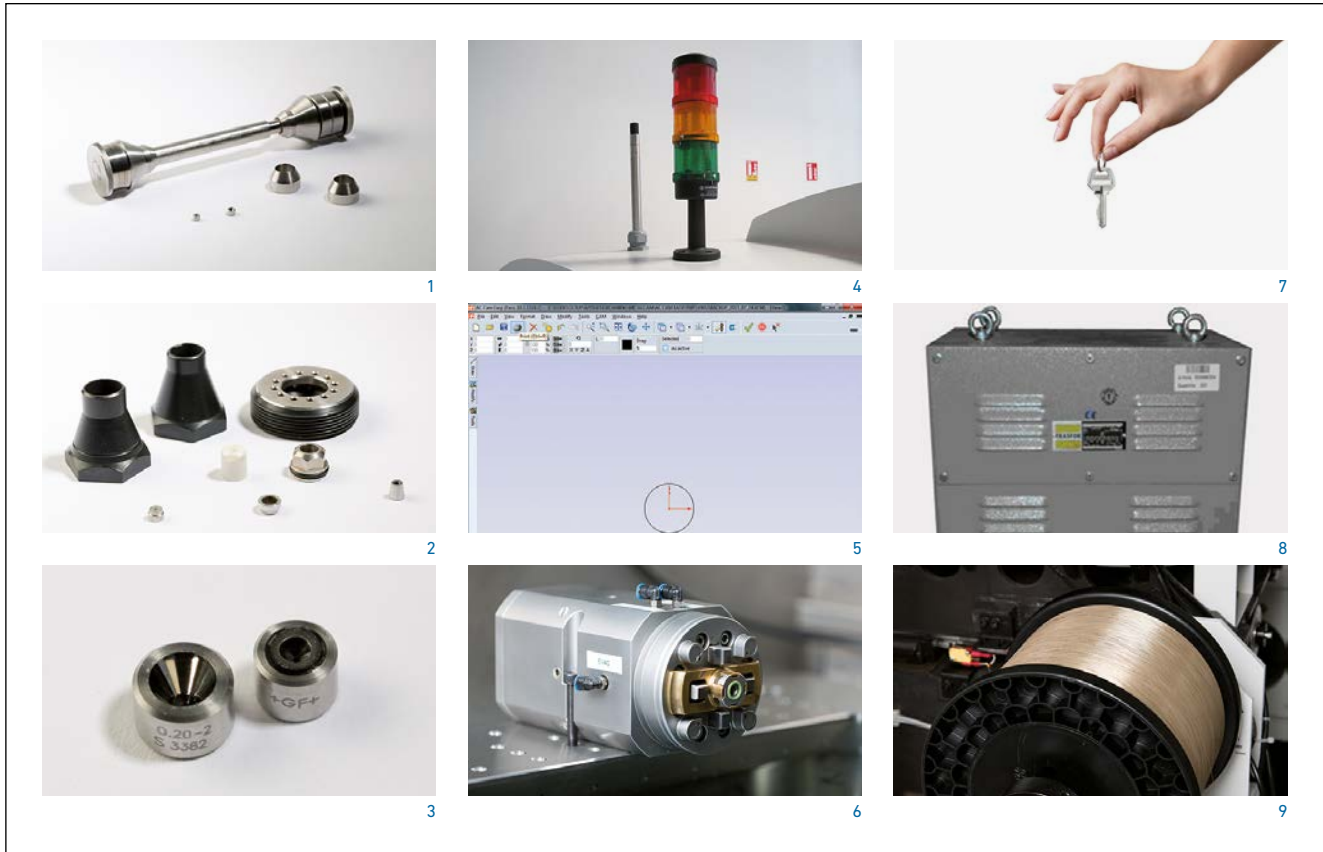

### 1 // Kit for wire diameter 0.100 mm

This set includes all the parts that ensure a good machining reliability when using a wire diameter of 0.1 mm.

### 2 // Taper kit

Option for accurate taper cutting

- One set of large radius guides
- One threading nozzle
- One set of nuts

Available for 0.2 and 0.25 mm diameter wires.

### 3 // Set of wire guides

Set of two closed wire guides in diamond with clearance.

- Available diameters:  
0.1, 0.15, 0.2, 0.25, 0.3 mm

### 4 // Alarm lamp

Stack lamp for the visualization of the equipment status

- Stack three-light unit (green, yellow, red)
- Mounting material

### 5 // AC CAM EASY

#### - Professional license

This option is the updated package from the basic version to professional version.

#### - Advanced license

This option is the updated package from the basic version to advanced version.

### 6 // Automatic indexing chuck

Autoindexer is an integrated rotary indexing unit with continuous 90° capability intended for submerged use in wire EDM machines.

### 7 // Additional year parts warranty

This is an extension of the first year warranty.

The contract is on the same legal basis as applicable to the first year warranty for the parts only. Consumables and wear parts are excluded. This option must be purchased when the machine is ordered.

### 8 // 18 kVA external transformer

### 9 // Large wire spools up to 25 kg for more running hours

Our Service + Success range

# We take you to new heights

## Guiding your ascent

Whether it is Milling, EDM, Laser Texturing or Additive Manufacturing, our Service + Success experts guide you throughout the entire lifecycle of our Machining and Automation tools in order to help you reach your peak performance. Our trusted experts backed by our latest cutting-edge, intelligent Digital Solutions, provide a **full range of services**.



**Operational steering**  
Hands-on and operational service interventions with supply of consumables and wear parts



**Advanced diagnosis**  
Machine check-up, preventive maintenance and advanced services including original spare parts availability in all our hubs around the world



**Certification**  
State-of-the-art reference by industry sector and on machining equipment



**Upgrades**  
Designed to add value to the original machine investment in order to achieve higher sustainable productivity



**Training**  
Performance oriented academy with a human-centric approach of knowledge transfer in order to realize the full potential of our solutions



**Transformation**  
Strategic partnership from made-to-measure advice on business model evolution to industrial implementation



**Financial solutions**  
For the optimization of operating costs featuring minimal initial expenditure programs and leasing options

# Our Success Packs

As a long-time partner, since 1802 we have been serving various industrial segments and have been dedicated to providing you with a first-in-class combination of services.

We have conceived our new Success Packs range for maximizing **your return on investment**, empowering you in your quest for success whatever your industrial profile.



**Silver +**  
Secure  
your future



**Silver**  
Set the foundation  
for growth



**Bronze +**  
Achieve flawless  
production



**Bronze**  
Get back on  
track fast



## Technical specifications



**CUT E 350**



**CUT E 350**

		<b>CUT E 350</b>	<b>CUT E 600</b>
<b>Machine</b>			
Dimensions of complete equipment *	mm	1750 x 2470 x 2200	2020 x 2790 x 2320
	in	68.9 x 97.24 x 86.61	79.53 x 109.84 x 91.34
Total weight of equipment without dielectric	kg (lbs)	2525 (5567)	4440 (9789)
<b>Work area</b>			
Part dimensions	mm	820 x 680 x 245	1030 x 800 x 345
	in	32.28 x 26.77 x 9.64	40.55 x 31.5 x 13.58
Max. part weight	kg (lbs)	400 (882)	1000 (2205)
Level of dielectric min./max.	mm (in)	0/240 (0/9.45)	0/380 (0/14.96)
<b>Air supply</b>			
Pressure	bar	6-7	6-7
Min. flow	l/min	150 (39.6 gal/min)	150 (39.6 gal/min)
<b>Axes</b>			
X, Y, Z Travel	mm	350 x 250 x 250	600 x 400 x 350
	in	13.78 x 9.84 x 9.84	23.62 x 15.75 x 13.78
U, V Travel	mm (in)	± 45 (± 1.77)	± 50 (± 1.97)
Taper angle/height	°/mm	± 30/56 or ± 25/96	± 30/56 or ± 25/96
	°/in	± 30/2.20 or ± 25/3.78	± 30/2.20 or ± 25/3.78
X, Y, U, V, Z measurement resolution	µm (µ-inch)	0.1 (3.94)	0.1 (3.94)
Speed of axis movement (XYZ)	mm/min (in/min)	0-3000 (0-118.1)	0-3000 (0-118.1)
Anti-collision protection for axes		X, Y, Z	X, Y, Z
<b>Dielectric</b>			
Type		Deionised water	Deionised water
Total volume of dielectric	l	760 (200.77 gal)	1000 (264.17 gal)
Filtering cartridges		2	2
Deionization bottle (not standard)	l	1 (0.26 gal)	1 (0.26 gal)
Deionization resin (not standard)	l	20 (5.3 gal)	20 (5.3 gal)

\* Width x depth x height



**CUT E 600**



**CUT E 600**

		<b>CUT E 350</b>	<b>CUT E 600</b>
<b>Electrode/Wire</b>			
Standard wire guide	mm in	Ø 0.20 or Ø 0.25 Ø 0.008 or Ø 0.010	Ø 0.20 or Ø 0.25 Ø 0.008 or Ø 0.010
Wire diameter (according to configuration equipment)	mm in	Ø 0.1-0.3 Ø 0.004-0.012	Ø 0.1-0.3 Ø 0.004-0.012
Automatic threading for wires	mm in	Ø 0.1-0.3 Ø 0.004-0.012	Ø 0.1-0.3 Ø 0.004-0.012
Automatic rethreading for wires	mm in	Ø 0.1-0.3 Ø 0.004-0.012	Ø 0.1-0.3 Ø 0.004-0.012
Min. diameter of pre-hole for automatic threading	mm in	Ø 0.2-0.3 Ø 0.008-0.012	Ø 0.2-0.3 Ø 0.008-0.012
Max. height for automatic threading with 0.25 mm wire (0.010 inch)	mm in	220 8.66	220 8.66
Permissible weights and types of reel	kg lbs	5 (JIS P5), 25 (DIN 160) 11.02 (JIS P5), 55.11 (DIN 160)	5 (JIS P5), 25 (DIN 160) 11.02 (JIS P5), 55.11 (DIN 160)
Best Ra Tungsten Carbide/Steel	µm (µ-inch)	0.12/0.18 (4.72/7.09)	0.12/0.18 (4.72/7.09)
Max. machine cutting speed	mm <sup>2</sup> /min (in <sup>2</sup> /min)	300 (0.46)	300 (0.46)
<b>Cabinet</b>			
Three-phase input voltage	V	380/400	380/400
Network frequency	Hz	50 or 60	50 or 60
Permissible fluctuations		± 10%	± 10%
Total installed power	kVA	10	10
Permissible micro-break	ms	4	4
Power factor		0.8	0.8
Screen/Operating system		TFT 19"/Windows 7	TFT 19"/Windows 7
CD-ROM/Keyboard		No/No	No/No
Ethernet port USB		Yes	Yes
Remote control		Yes	Yes
<b>Ambient conditions</b>			
Temperature for optimum accuracy		20 ± 1°C (68 ± 33.8°F)	20 ± 1°C (68 ± 33.8°F)
Temperature for operation of the equipment		15-30°C (59-86°F)	15-30°C (59-86°F)
Permissible relative humidity		40-80%	40-80%
Max. sound emission of the machine	Db(A)	76	76
Thermal stabilization time	h	3	3
Level of protection of electrical equipment	IP	43	43

**CUT E 350**

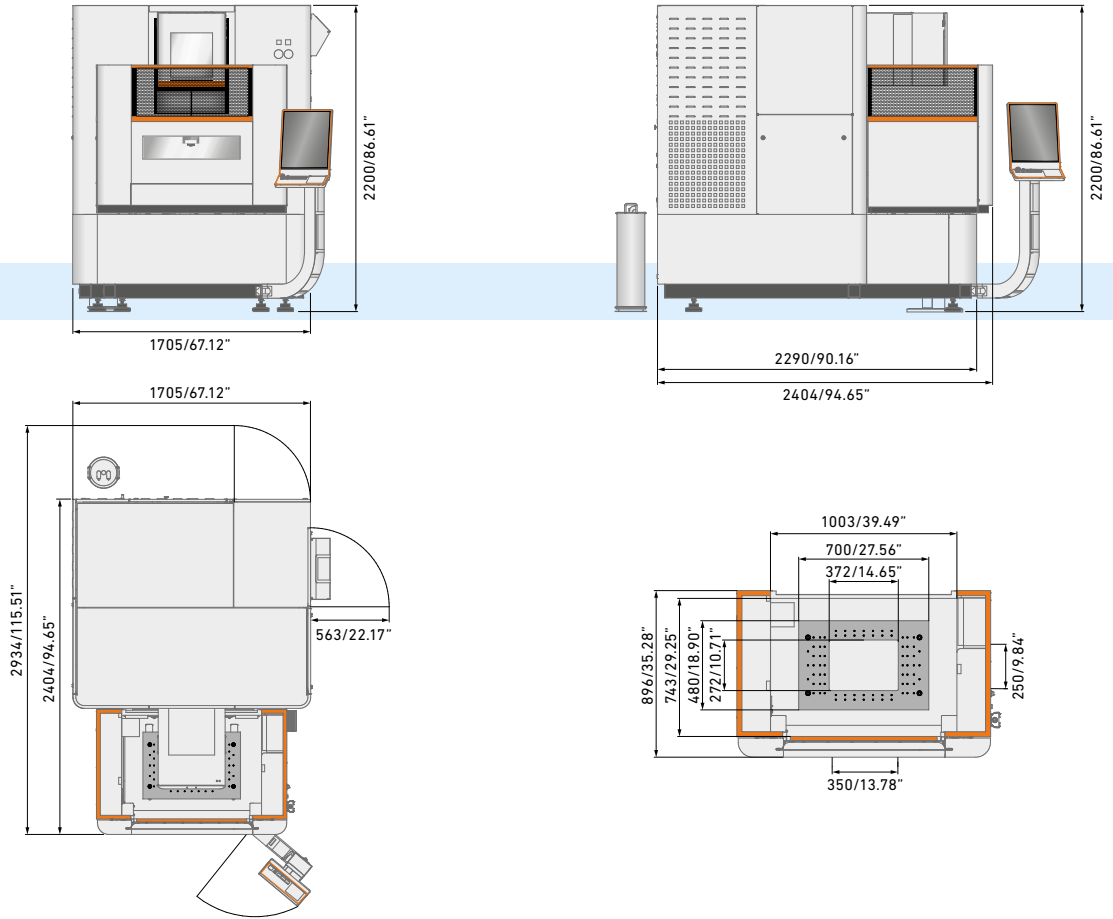

**CUT E 600**

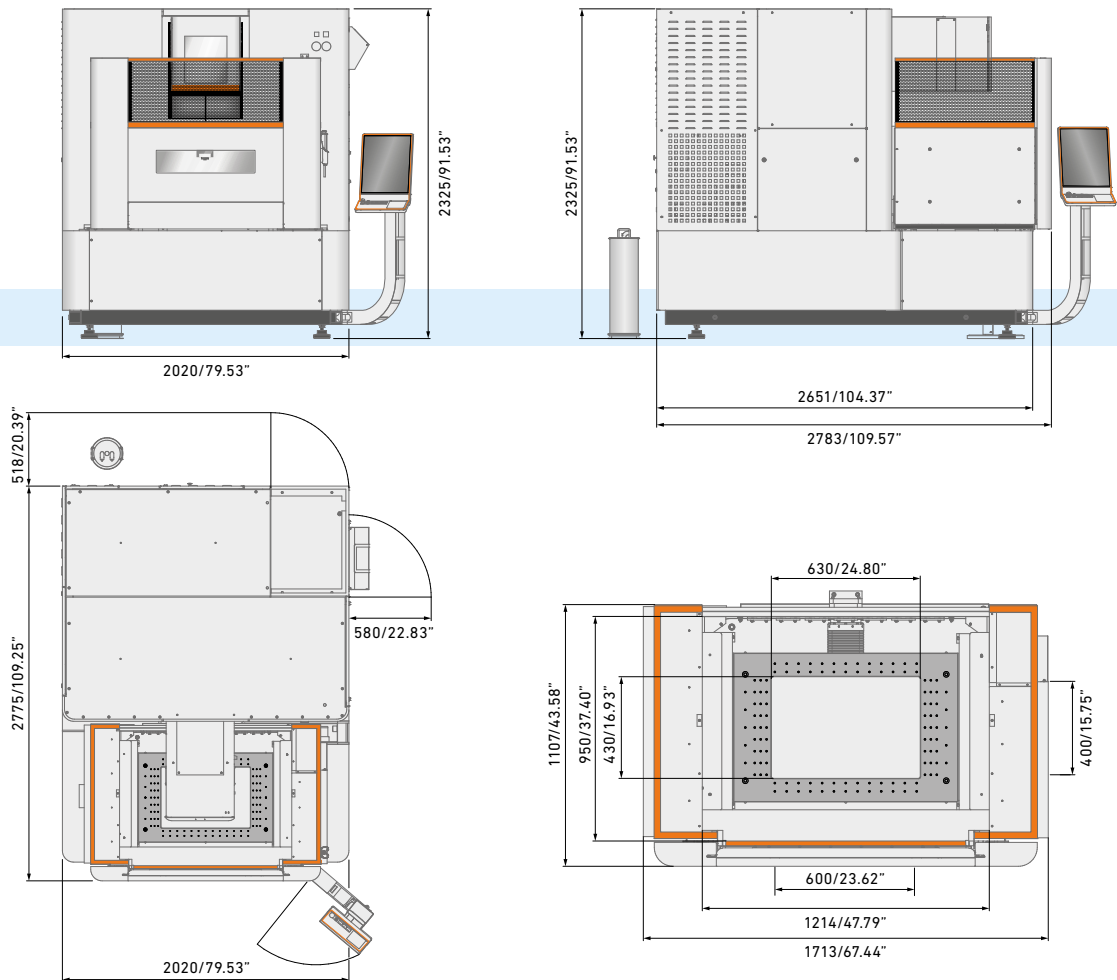



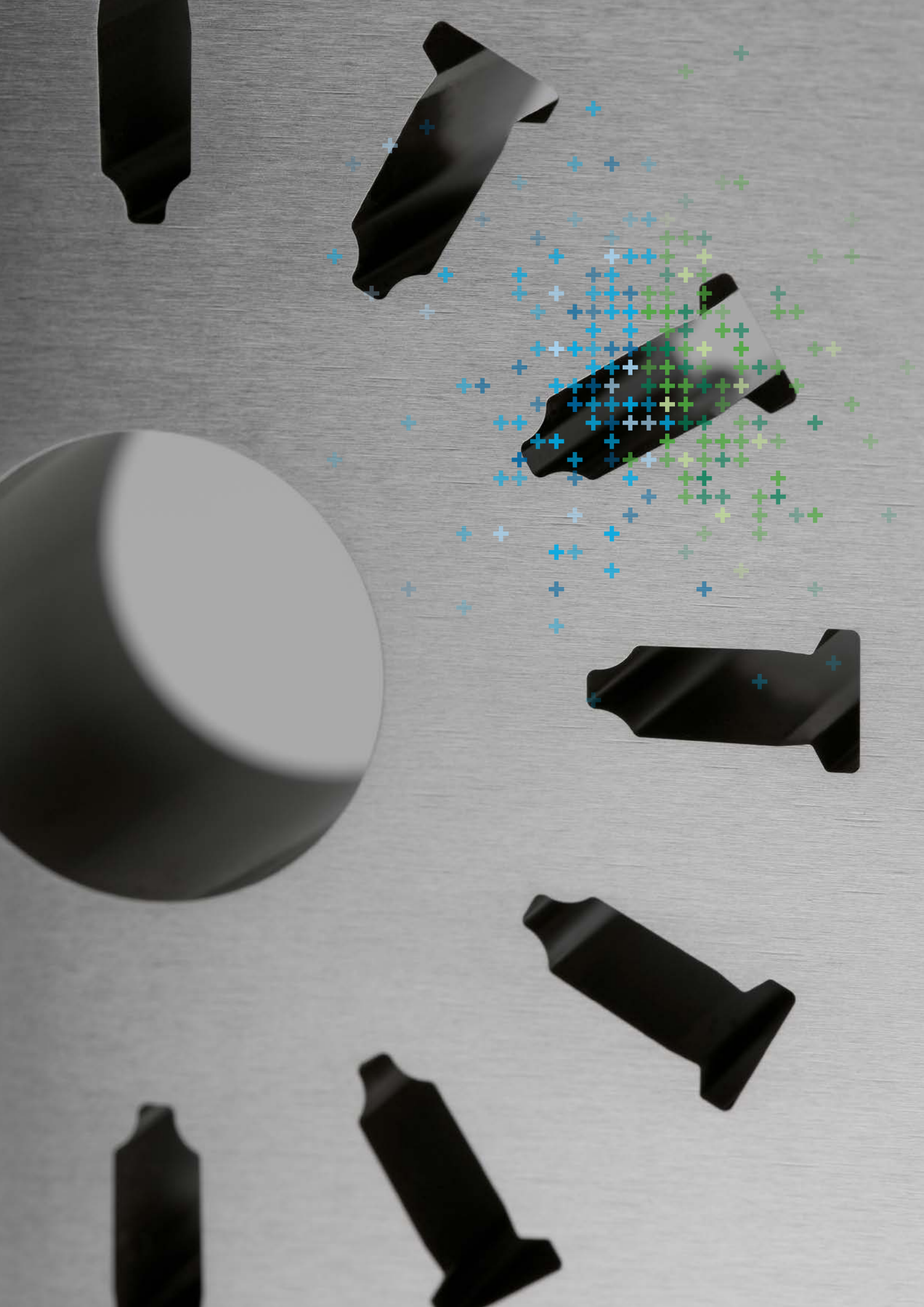

## About GF Machining Solutions

# Multi-technology solutions provider

Our commitment to you and your specific applications is proven by the value-adding intelligence, productivity and quality delivered by our multi-technology solutions. Your success is our chief motivator. That's why we are continuously advancing our legendary technical expertise. Wherever you are, whatever your market segment and whatever the size of your operation, we have the complete solutions and the customer-centric commitment to accelerate your success—today.

### EDM (Electrical Discharge Machining)



#### Wire-cutting EDM

GF Machining Solutions' wire-cutting EDM is fast, precise and increasingly energy efficient. From ultraprecise machining of miniaturized components down to 0.02 mm to powerful solutions for demanding high-speed machining with respect to surface accuracy, our wire EDM solutions position you for success.

#### Die-sinking EDM

GF Machining Solutions is revolutionizing die-sinking EDM with features like iGAP technology to dramatically boost machining speed and reduce electrode wear. All of our die-sinking systems offer fast removal and deliver mirror finishes of Ra 0.1 µm (4 µin).

#### Hole-drilling EDM

GF Machining Solutions' robust hole-drilling EDM solutions enable you to drill holes in electrically conductive materials at a very high speed—and, with a five-axis configuration, at any angle on a workpiece with an inclined surface.

### Milling



#### Milling

Precision tool and mold manufacturers enjoy a competitive edge with our Mikron MILL S solutions' fast and precise machining. The Mikron MILL P machines achieve above-average productivity thanks to their high performance and Automation. Customers seeking fastest return on investment benefit from the affordable efficiency of our MILL E solutions.

#### High Performance Airfoil Machining

Our Liechti turnkey solutions enable the highly dynamic manufacturing of precision airfoils. Thanks to the unique performance and our expertise in airfoil machining, you increase productivity by producing at the lowest cost per part.

#### Spindles

As part of GF Machining Solutions, Step-Tec is engaged in the very first stage of each machining center development project. Compact design combined with excellent thermal and geometric repeatability ensure the perfect integration of this core component into the machine tool.

### Advanced manufacturing



#### Laser texturing

Aesthetic and functional texturing is easy and infinitely repeatable with our digitized Laser technology. Even complex 3D geometries, including precision parts, are textured, engraved, microstructured, marked and labeled.

#### Laser micromachining

GF Machining Solutions offers the industry's most complete line of Laser micromachining platforms optimized for small, high-precision features to meet the increasing need for smaller, smarter parts to support today's leading-edge products.

#### Laser Additive Manufacturing (AM)

GF Machining Solutions and 3D Systems, a leading global provider of additive manufacturing solutions and the pioneer of 3D printing, have partnered to introduce new metal 3D printing solutions that enable manufacturers to produce complex metal parts more efficiently.

### Tooling and Automation



#### Tooling

Our customers experience complete autonomy while maintaining extreme accuracy, thanks to our highly accurate System 3R reference systems for holding and positioning electrodes and work pieces. All types of machines can easily be linked, which reduces set-up times and enables a seamless transfer of workpieces between different operations.

#### Automation

Together with System 3R, we also provide scalable and cost-effective Automation solutions for simple, single machine cells or complex, multi-process cells, tailored to your needs.

### Software



#### Digitalization solutions

To drive its digital transformation, GF Machining Solutions acquired symmedia GmbH, a company specialized in software for machine connectivity. Together, we offer a complete range of Industry 4.0 solutions across all industries. The future requires the ability to adapt quickly to continual digital processes. Our intelligent manufacturing offers embedded expertise, optimized production processes, and workshop Automation: solutions for smart and connected machines.

### Service + Success



#### We take you to new heights

Our Success Packs are designed to maximise your return on investment and empower you in your quest for success across all industrial segments. Our subscription packs feature a comprehensive range of services that guarantee the access and support you need to get the most out of your assets today, while preparing for the challenges of tomorrow. Our trusted experts backed by our latest cutting-edge, intelligent Digital Solutions, provide a full range of services.



## Switzerland

---

Biel/Bienne  
Losone  
Geneva  
Flawil  
Langnau

[www.gfms.com](http://www.gfms.com)  
[www.gfms.com/ch](http://www.gfms.com/ch)

## Europe

---

Germany, Schorndorf  
[www.gfms.com/de](http://www.gfms.com/de)

United Kingdom, Coventry  
[www.gfms.com/uk](http://www.gfms.com/uk)

Italy, Agrate Brianza - MI  
[www.gfms.com/it](http://www.gfms.com/it)

Spain, Sant Boi de Llobregat  
Barcelona  
[www.gfms.com/es](http://www.gfms.com/es)

France, Palaiseau  
[www.gfms.com/fr](http://www.gfms.com/fr)

Poland, Raszyn / Warsaw  
[www.gfms.com/pl](http://www.gfms.com/pl)

Czech Republic, Brno  
[www.gfms.com/cz](http://www.gfms.com/cz)

Sweden, Vällingby  
[www.gfms.com/system3r](http://www.gfms.com/system3r)

Turkey, Istanbul  
[www.gfms.com/tr](http://www.gfms.com/tr)

## Americas

---

USA  
Lincolnshire, IL  
Chicago, IL  
Holliston, MA  
Huntersville, NC  
Irvine, CA  
Woodridge, IL  
[www.gfms.com/us](http://www.gfms.com/us)

Canada, Mississauga ON  
[www.gfms.com/us](http://www.gfms.com/us)

Mexico, Monterrey NL  
[www.gfms.com/us](http://www.gfms.com/us)

Brazil, São Paulo  
[www.gfms.com/br](http://www.gfms.com/br)

## Asia

---

China  
Beijing, Shanghai,  
Chengdu, Dongguan,  
Hong Kong, Changzhou  
[www.gfms.com/cn](http://www.gfms.com/cn)

India, Bangalore  
[www.gfms.com/sg](http://www.gfms.com/sg)

Japan  
Tokyo, Yokohama  
[www.gfms.com/jp](http://www.gfms.com/jp)

Korea, Seoul  
[www.gfms.com/kr](http://www.gfms.com/kr)

Malaysia, Petaling Jaya  
[www.gfms.com/sg](http://www.gfms.com/sg)

Singapore, Singapore  
[www.gfms.com/sg](http://www.gfms.com/sg)

Taiwan  
Taipei, Taichung  
[www.gfms.com/tw](http://www.gfms.com/tw)

Vietnam, Hanoi  
[www.gfms.com/sg](http://www.gfms.com/sg)

## At a glance

We enable our customers to run their businesses efficiently and effectively by offering innovative Milling, EDM, Laser, Additive Manufacturing, Spindle, Tooling and Automation solutions. A comprehensive package of services completes our proposition.

[www.gfms.com](http://www.gfms.com)

